

# Partial List of Plumbing Hazards

## Fixtures with Direct Connections

Sewer, sanitary  
Sewer, storm  
Swimming pool

### Description

Air conditioning, air washer  
Air conditioning, chilled water  
Air conditioning, condenser water  
Air line  
Aspirator, laboratory  
Aspirator, medical  
Aspirator, weedicide and fertilizer sprayer  
Autoclave and sterilizer  
Auxiliary system, industrial  
Auxiliary system, surface water  
Auxiliary system, unapproved well supply  
Boiler system  
Chemical feeder, pot-type  
Chlorinator  
Coffee urn  
Cooling system  
Dishwasher  
Fire standpipe or sprinkler system  
Fountain, ornamental  
Hydraulic equipment  
Laboratory equipment  
Lubrication, pump bearings  
Photostat equipment  
Plumber's friend, pneumatic  
Pump, pneumatic ejector  
Pump, prime line  
Pump, water operated ejector

## Fixtures with Submerged Inlets

### Description

Baptismal fount  
Bathtub  
Bedpan washer, flushing rim  
Bidet  
Brine tank  
Cooling tower  
Cuspidor  
Drinking fountain  
Floor drain, flushing rim  
Garbage can washer  
Ice maker  
Laboratory sink, serrated nozzle  
Laundry machine  
Lavatory  
Lawn sprinkler system  
Photo laboratory sink  
Sewer flushing manhole  
Slop sink, flushing rim  
Slop sink, threaded supply  
Steam table  
Urinal, siphon jet blowout  
Vegetable peeler  
Water closet, flush tank, ball cock  
Water closet, flush valve, siphon jet

# Illustrations of Backsiphonage

The following illustrates typical plumbing installations where backsiphonage is possible.

## Backsiphonage

Case I (Fig. 44)

**A. Contact Point:** A rubber hose is submerged in a bedpan wash sink.

**B. Causes of Reversed Flow:** (1) A sterilizer connected to the water supply is allowed to cool without opening the air vent. As it cools, the pressure within the sealed sterilizer drops below atmospheric producing a vacuum which draws the polluted water into the sterilizer contaminating its contents. (2) The flushing of several flush valve toilets on a lower floor which are connected to an

undersized water service line reduces the pressure at the water closets to atmospheric producing a reversal of the flow. **C. Suggested Correction:** The water connection at the bedpan wash sink and the sterilizer should be provided with properly installed backflow preventers.

## Backsiphonage

Case 2 (Fig. 45)

**A. Contact Point:** A rubber hose is submerged in a laboratory sink.

**B. Cause of Reversed Flow:** Two opposite multi-story buildings are connected to the same water main, which often lacks adequate pressure. The building on the right has installed a booster pump.

FIGURE 44.  
Backsiphonage (Case 1).

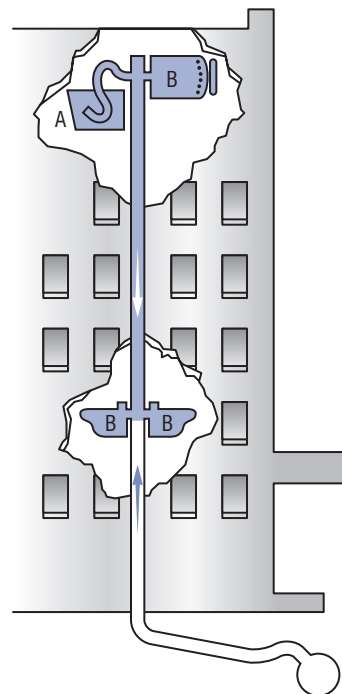
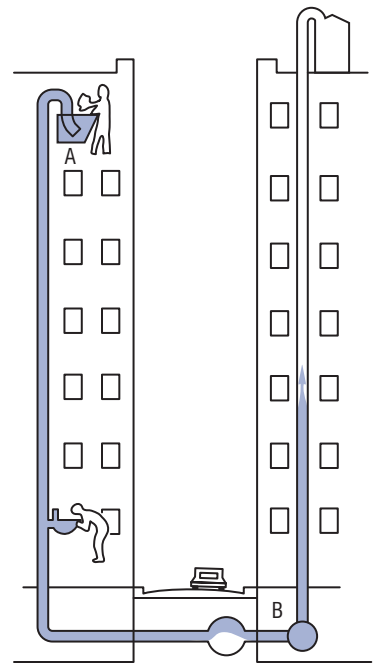


FIGURE 45.  
Backsiphonage (Case 2).



When the pressure is inadequate in the main, the building booster pump starts pumping, producing a negative pressure in the main and causing a reversal of flow in the opposite building.

**C. Suggested Correction:** The laboratory sink water outlet should be provided with a vacuum breaker. The water service line to the booster pump should be equipped with a device to cut off the pump when pressure approaches a negative head or vacuum.

## Backsiphonage

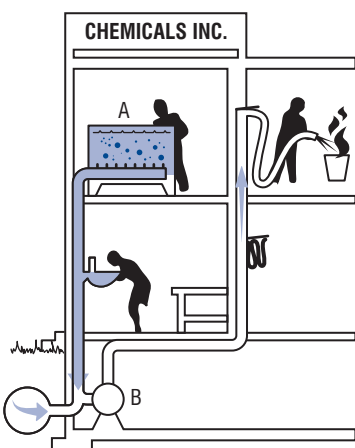
Case 3 (Fig. 46)

**A. Contact Point:** A chemical tank has a submerged inlet.

**B. Cause of Reversed Flow:** The plant fire pump draws suction directly from the city water supply line which is insufficient to serve normal plant requirements and a major fire at the same time. During a fire emergency, reversed flow may occur within the plant.

**C. Suggested Correction:** The water service to the chemical tank should be provided through an air gap.

FIGURE 46. Backsiphonage (Case 3).



## Backsiphonage

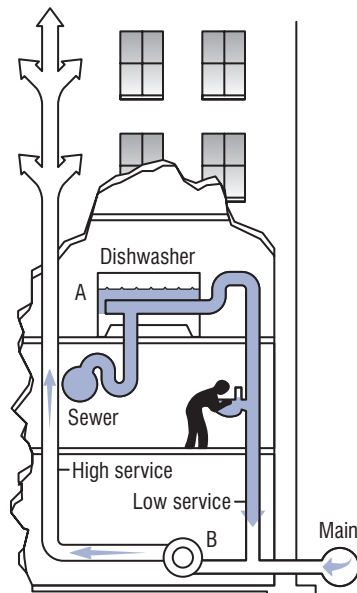
Case 4 (Fig. 47)

**A. Contact Point:** The water supply to the dishwasher is not protected by a vacuum breaker. Also, the dishwasher has a solid waste connection to the sewer.

**B. Cause of Reversed Flow:** The undersized main serving the building is subject to reduced pressures, and therefore only the first two floors of the building are supplied directly with city pressure. The upper floors are served from a booster pump drawing suction directly from the water service line. During periods of low city pressure, the booster pump suction creates negative pressures in the low system, thereby reversing the flow.

**C. Suggested Correction:** The dishwasher hot and cold water should be supplied through an air gap and the waste from the dishwasher should discharge through an indirect waste. The booster pump should be equipped with a low-pressure cutoff device.

FIGURE 47. Backsiphonage (Case 4).



## Backsiphonage

Case 5 (Fig. 48)

**A. Contact Point:** The gasoline storage tank is maintained full and under pressure by means of a direct connection to the city water distribution system.

FIGURE 48. Backsiphonage (Case 5).

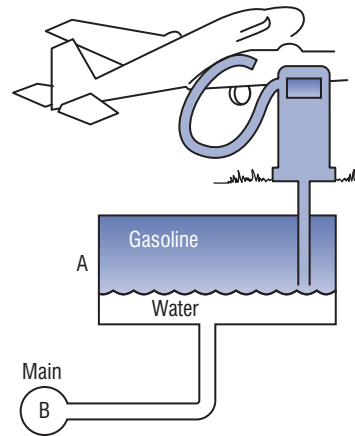
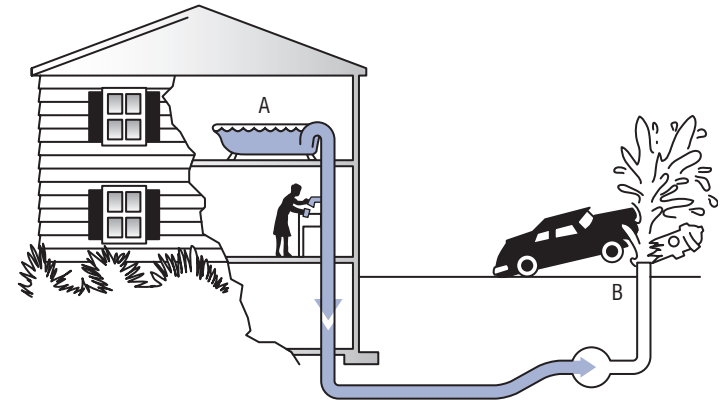


FIGURE 49. Backsiphonage (Case 6).



**B. Cause of Reversed Flow:** Gasoline may enter the distribution system by gravity or by siphonage in the event of a leak or break in the water main.

**C. Suggested Correction:** A reduced pressure principle backflow preventer should be installed in the line to the gasoline storage tank or a surge tank and pump should be provided in that line.

## Backsiphonage

Case 6 (Fig. 49)

**A. Contact Point:** There is a submerged inlet in the second floor bathtub.

**B. Cause of Reversed Flow:** An automobile breaks a nearby fire hydrant causing a rush of water and a negative pressure in the service line to the house, sucking dirty water out of the bathtub.

**C. Suggested Correction:** The hot and cold water inlets to the bathtub should be above the rim of the tub.

# Illustrations of Backpressure

The following presents illustrations of typical plumbing installations where backflow resulting from backpressure is possible.

## Backflow

Case I (Fig. 50)

**A. Contact Point:** A direct connection from the city supply to the boiler exists as a safety measure and for filling the system. The boiler water system is chemically treated for scale prevention and corrosion control.

**B. Cause of Reversed Flow:** The boiler water recirculation pump discharge pressure or backpressure from the boiler exceeds the city water pressure and the chemically treated water is pumped into the domestic system through an open or leaky valve.

**C. Suggested Correction:** As minimum protection two check valves in series should be provided in the makeup waterline to the boiler system. An air gap separation or reduced pressure principle backflow preventer is better.

FIGURE 50. Backflow (Case 1).

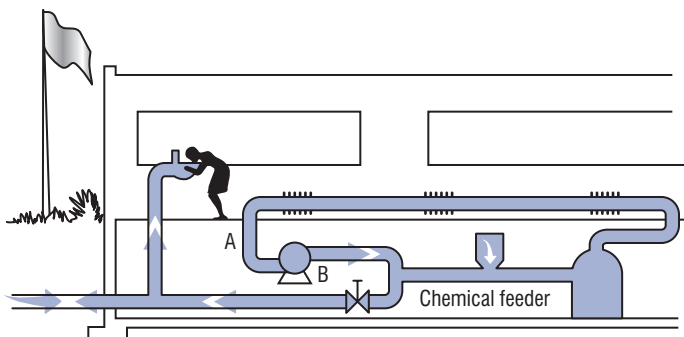
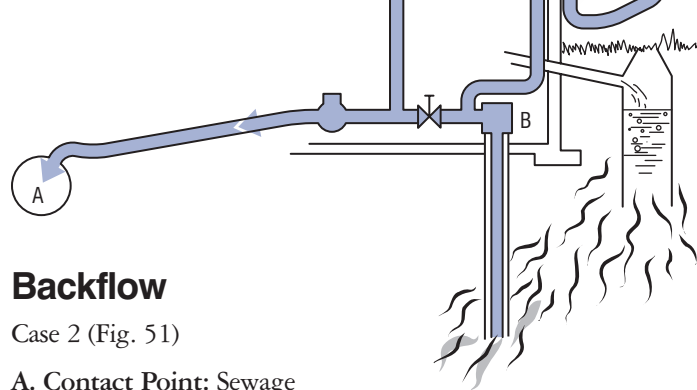


FIGURE 51. Backflow (Case 2).



## Backflow

Case 2 (Fig. 51)

**A. Contact Point:** Sewage seeping from a residential cesspool pollutes the private well which is used for lawn sprinkling. The domestic water system, which is served from a city main, is connected to the well supply by means of a valve. The purpose of the connection may be to prime the well supply for emergency domestic use.

**B. Cause of Reversed Flow:** During periods of low city water pressure, possibly when lawn sprinkling is at its peak, the well pump discharge pressure exceeds that of the city main and well water is pumped into the city supply through an open or leaky valve.

**C. Suggested Correction:** The connection between the well water and city water should be broken

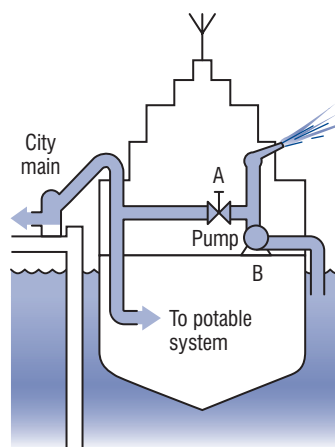
## Backflow

Case 3 (Fig. 52)

**A. Contact Point:** A valve connection exists between the potable and the non-potable systems aboard the ship.

**B. Cause of Reversed Flow:** While the ship is connected to the city water supply system for the purpose of taking on water for the potable system, the valve between the potable and non-potable systems is opened, permitting contaminated water to be pumped into the municipal supply.

FIGURE 52. Backflow (Case 3).



**C. Suggested Correction:** Each pier water outlet should be protected against backflow. The main water service to the pier should also be protected against backflow by an air gap or reduced pressure principle backflow preventer.

## Backflow

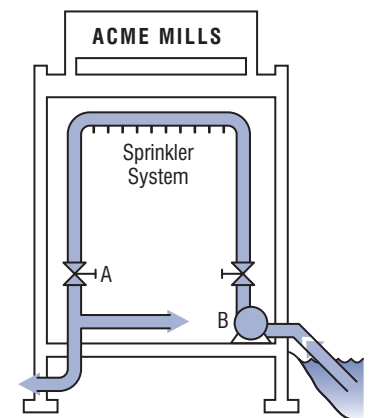
Case 4 (Fig. 53)

**A. Contact Point:** A single-valved connection exists between the public, potable water supply and the fire-sprinkler system of a mill.

**B. Cause of Reversed Flow:** The sprinkler system is normally supplied from a nearby lake through a high-pressure pump. About the lake are large numbers of overflowing septic tanks. When the valve is left open, contaminated lake water can be pumped to the public supply.

**C. Suggested Correction:** The potable water supply to the fire system should be through an air gap or a reduced pressure principle backflow preventer should be used.

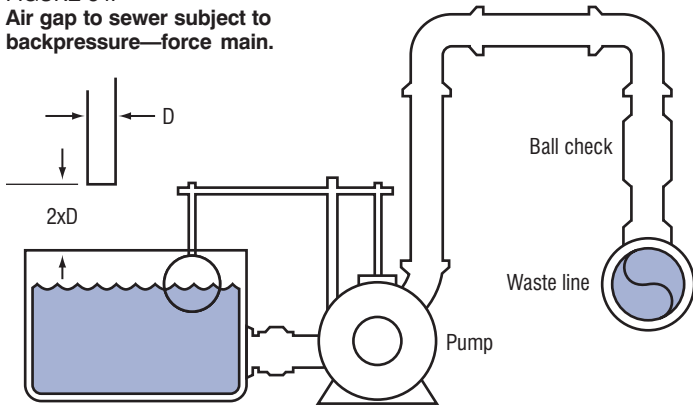
FIGURE 53. Backflow (Case 4).



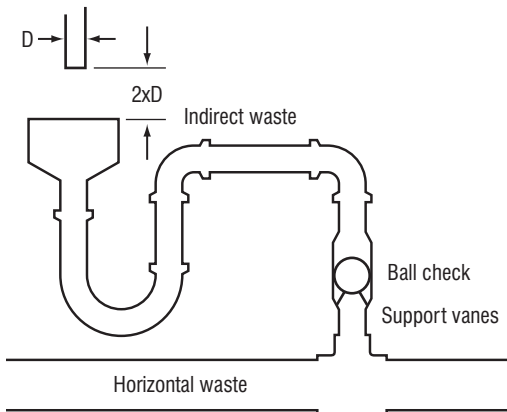
# Illustrations of Air Gaps

The following illustrations describe methods of providing an air gap discharge to a waste line which may be occasionally or continuously subject to backpressure.

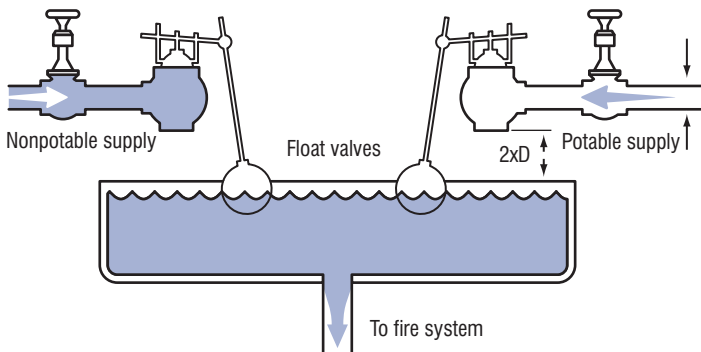
**FIGURE 54.**  
Air gap to sewer subject to backpressure—force main.



**FIGURE 55.**  
Air gap to sewer subject to backpressure—gravity drain.

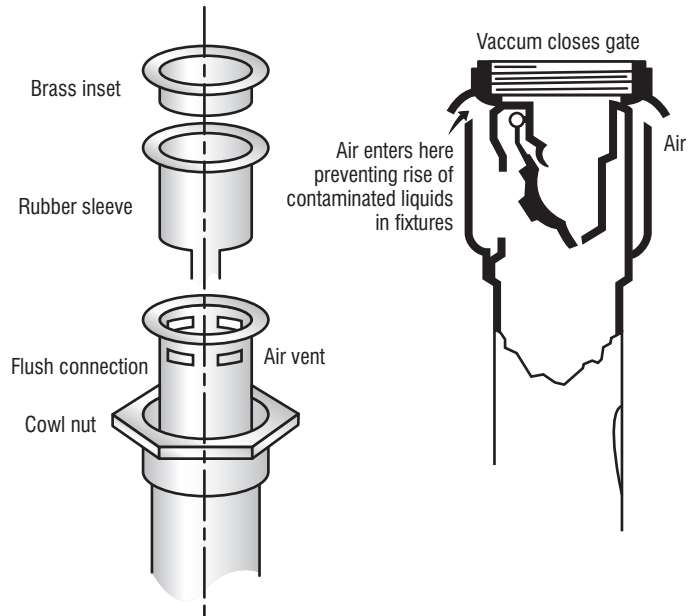


**FIGURE 56.**  
Fire system makeup tank for a dual water system.

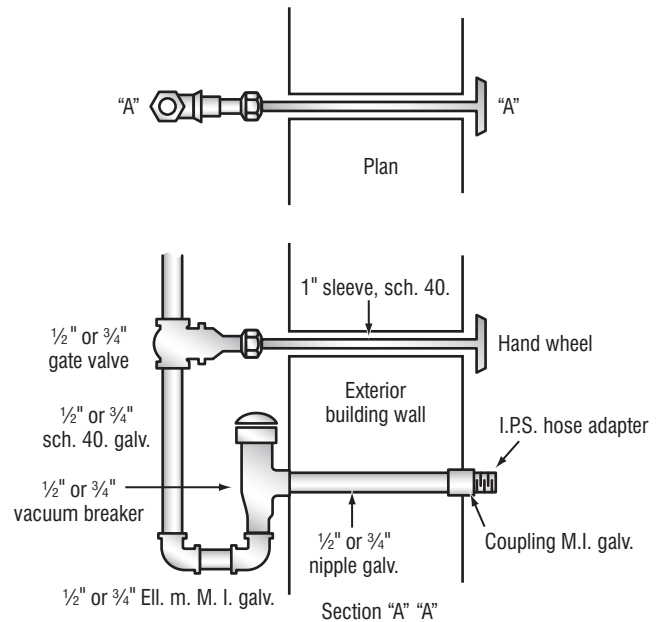


# Illustrations of Vacuum Breakers

**FIGURE 57.**  
Vacuum breakers.



**FIGURE 58.**  
Vacuum breaker arrangement for an outside hose hydrant.



(By permission of Mr. Gustave J. Angele Sr., P.E. formerly Plant Sanitary Engineer, Union Carbide Nuclear Division, Oak Ridge, Tenn.)

# Glossary

- Air gap** The unobstructed vertical distance through the free atmosphere between the lowest opening from any pipe or faucet supplying water to a tank, plumbing fixture, or other device and the flood-level rim of the receptacle.
- Backflow** The flow of water or other liquids, mixtures, or substances into the distributing pipes of a potable supply of water from any source or sources other than its intended source. Backsiphonage is one type of backflow.
- Backflow Connection** Any arrangement whereby backflow can occur.
- Backflow Preventer** A device or means to prevent backflow. Backflow Preventer, Reduced Pressure Principle Type An assembly of differential valves and check valves including an automatically opened spillage port to the atmosphere.
- Backsiphonage** Backflow resulting from negative pressures in the distributing pipes of a potable water supply.
- Cross-Connection** Any actual or potential connection between the public water supply and a source of contamination or pollution.
- Effective Opening** The minimum cross-sectional area at the point of water supply discharge, measured or expressed in terms of (1) diameter of a circle, or (2) if the opening is not circular, the diameter of a circle or equivalent cross-sectional area.
- Flood-Level Rim** The edge of the receptacle from which water overflows.
- Flushometer Valve** A device which discharges a predetermined quantity of water to fixtures for flushing purposes and is actuated by direct water pressure.
- Free Water Surface** A water surface that is at atmospheric pressure.
- Frostproof Closet** A hopper with no water in the bowl and with the trap and water supply control valve located below frost line.
- Indirect Waste Pipe** A drain pipe used to convey liquid wastes that does not connect directly with the drainage system, but which discharges into the drainage system through an air break into a vented trap or a properly vented and trapped fixture, receptacle, or interceptor.
- Plumbing** The practice, materials, and fixtures used in the installation, maintenance, extension, and alteration of all piping, fixtures, appliances and appurtenances in connection with any of the following: sanitary drainage or storm drainage facilities, the venting system and the public or private water-supply systems, within or adjacent to any building, structure, or conveyance; also the practice and materials used in the installation, maintenance, extension, or alteration of storm water, liquid waste, or sewerage, and water-supply systems of any premises to their connection with any point of public disposal or other acceptable terminal.
- Potable Water** Water free from impurities present in amounts sufficient to cause disease or harmful physiological effects. Its bacteriological and chemical quality shall conform to the requirements of the USEPA National Primary Drinking Water Regulations and the regulations of the public health authority having jurisdiction.
- Vacuum** Any absolute pressure less than that exerted by the atmosphere.
- Vacuum Breaker** A device that permits air into a water supply distribution line to prevent backsiphonage.
- Water Outlet** A discharge opening through which water is supplied to a fixture, into the atmosphere (except into an open tank which is part of the water supply system), to a boiler or heating system, to any devices or equipment requiring water to operate but which are not part of the plumbing system.
- Water Supply System** The water service pipe, the water-distributing pipes, and the necessary connecting pipes, fittings, control valves, and all appurtenances in or adjacent to the building or premises. The water supply system is part of the plumbing system.

# Bibliography

- Accepted Procedure and Practice in Cross-Connection Control Manual*, American Water Works Association, Pacific Northwest Section, 4th Edition. Nov. 1985.
- American Backflow Prevention Association, P.O. Box 1563 Akron, Ohio 44309-1563.
- Angele, Gustave *Cross-Connection and Backflow Prevention*, American Water Works Association. Supplementary Reading library Series – No. S106, New York 10016.
- A Revision of The Notional Plumbing Code*, ASA A40.8-1955, Report of the Public Health Service Technical Committee on Plumbing Standards. Sept. 15, 1962, Public Health Service, Washington 25, D.C.
- AWWA Standard For Backflow Prevention Devices - Reduced Pressure Principle and Double Check Valve Types (C509-78)*, American Water Works Association, Denver, Colorado, Reaffirmed 1983. Backflow Prevention and Cross-Connection Control, AWWA Manual M14, American Water Works Association, Denver, Colorado 1966.
- Backflow Prevention and Cross-Connection Control*, Ohio EPA, Office of Public. Water Supply. Second Edition, Revised Mar. 15, 1977. Backflow Prevention Devices—Selection, Installation, Maintenance, and Field Testing, CSA Standard B64.10M1981. Canadian Standards Association, Dec.1981.
- Backflow—The Manual of Cross-Connection Prevention in Public Water Supplies*, Missouri Dept. of Natural Resources.
- Canadian Plumbing Code 1980*, NRCC, No. 17305, Second Printing, Issued by the Associate Committee on the National Building Code, Natural Research Council of Canada, Ottawa.
- Control and Elimination of Cross-Connections, Panel Discussion, *Journal American Water Works Association*, Vol.50, No.1, 1960.
- Cross-Connection Complications, *The Capital's Health*, Vol. 11, No. 9, Dec. 1953, D.C. Dept. of Public Health, Washington, D.C.
- Cross-Connection Control*, American Water Works Association, British Columbia Section, Second Edition, Jan.1980. *Cross-Connection Control and Backflow Prevention Device Testing*, New England Water Works Association, August 1987.
- Cross-Connection Control and Backflow Prevention, Practice and Procedure Manual, Administrative Manual*, City of Winnipeg, Manitoba. Third Edition, April 1980.
- Cross-Connection Control*, Backflow Prevention Device Tester Certification Training Course, Public Drinking Water Program, Division of Environmental Quality, Department of Natural Resources, State of Missouri.
- Cross-Connection Control Manual*, Division of Sanitary Engineering, Tennessee Dept. of Public Health, 1975.
- Cross-Connection Control Regulation in Washington State*, Washington State Dept. of Social and Health Services, Denver, Colorado, 1974. Second Edition.
- Cross-Connection Control*, New York State Dept. of Health, Jan.1981.
- Cross-Connection Control Program*, State of Utah, Oct.1985, Travis Black.
- Cross-Connection Control*, Water Quality Division, Colorado Department of Health. Revised March 1983. Cross-Connection Control Survey, New England Water Works Association, August 1987.
- CSA Standards on Vacuum Breakers and Backflow Preventers*, B64 Series 1976 Canadian Standards Association, Dec.1976.
- Dawson, F. M., and Kalinske, A. A., Report on *Cross-Connections and Backsiphonage Research*, Technical Bulletin No. 1, National Association of Plumbing, Heating, Cooling Contractors, Washington, D.C.
- Evaluation of Backflow Prevention Devices—A State of the Art*, (N B SIR 76-1070) U.S. Environmental Protection Agency, Water Supply Division, Washington, D.C., June 1976.
- Hendrickson, Howard D. *Cross-Connection Control*, Part 1 & 2, August & September 1981 issues of Reeves Journal.
- How To Prevent Industrial Cross-Connection Dangers, *Water Works Engineering*, Feb. 1962. Manitoba Plumbing Code 1981, Issued by the Department of Labour and Manpower of the Province of Manitoba.
- Manual of Cross-Connection Control*, Dept. of Health and Hospitals, Denver, Colorado, 1977.
- Manual of Cross-Connection Control*, Foundation for Cross-Connection Control and Hydraulic Research, University of Southern California, 7th Editions, June 1985.
- Manual of Cross-Connection Control Practices and Procedures*, State of California, Health and Welfare Agency, July 1981.
- Plumbing and Drainage Act Regulations*, Alberta, as amended by Alberta Regulations (295/80).
- Regulations Relating To Cross-Connections*, excerpt from the California Administrative Code, Title 17, Public Health, 1956.
- Saskatchewan Regulations 8/78*, Regulations Governing Plumbing and Drainage
- Solar Domestic Hot Water Systems and the Water Purveyor*, American Water Works Association, Pacific Northwest Section.
- Springer, E. K., and Reynolds, K. C., *Definitions and Specifications of Double Check Valve Assemblies and Reduced Pressure Principle Backflow Prevention Devices*, University of Southern California, School of Engineering Dept. 48-101, Jan. 30, 1959.
- Taylor, F. B., and Skodje, M. T., *Cross-Connections, A Hazard in All Buildings, Modern Sanitation and Building Maintenance*, Vol.14, No.8, Aug. 1962.
- Use of Backflow Preventers for Cross-Connection Control, Joint Committee Report, *Journal American Water Works Association*, Vol. 50, No.12, Dec. 1958.
- Van Meter, R. O., Backflow Prevention Hardware, *Water and Wastes Engineering*, Pt. 1, Sept. 1970; Pt. 2, Oct. 1970.



WH-550  
United States  
Environmental Protection  
Agency  
Washington, DC 20460

Official Business  
Penalty for Private Use  
\$300

Office of Water (4606M)  
EPA 816-R-03-002  
[www.epa.gov/safewater](http://www.epa.gov/safewater)  
February 2003